

MPPT Solar Charge Controller M4850N/M4860N

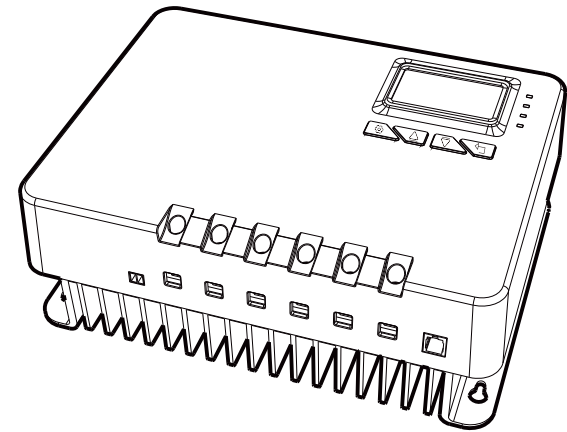





User Manual



Download APP on Apple Store / Google Play Store

*We may modify these specifications without prior notice.

1. Warnings and Tools Icon Chart

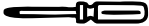
Icons	Name	Description
	High Voltage	High voltage device. Installation should be performed by an electrician.
	High Temperature	This device will produce heat. Mount device away from other items.
	Environmental Hazard	Electronic Equipment. Do not put in landfill.
	Wire Cutter	A wire cutter is needed for cutting and stripping prior wires to connect.
	Multi-meter	A multi-meter is needed for testing equipment and verifying polarity of cables.
	Anti-static Glove	Anti-static gloves are recommended to prevent controller damage caused by static electricity.
	Electrical Tape	Electrical tape is recommended to safely insulate spliced or bare wires.
	Screwdriver	A common size screwdriver is needed to attach wires to the controller.

2. Safety Tips

- It is very important to review this manual thoroughly before attempting installation.
- Beware of any nearby electrical equipment that may interfere with installing this device. And please don't plug in any AC source to this DC-DC product, or it may cause a fire or burn to the device.
- Lithium batteries are not allowed to be reverse connected, for risks might happen in battery activation if the wiring connection reversed.
 - Don't plug in power inverter directly to the controller DC load output, or it might cause short-circuit in this device or even fire due to over-current.
- Always keep children away from this device.
- Please don't keep the battery side open for long time, while the PV input keeps plugging in, or it may cause a screen failure in this device.
- Solar panels can generate high voltages and currents, make sure your solar panels are completely covered from sunlight during installation. It is recommended that installation be performed by a qualified electrician.
- To avoid damage to the battery or controller, use proper fuses or DC breakers in wiring. Please do not hesitate to contact the professions if you need help with fuse and DC breaker sizing.
- Connecting wires to this device can generate sparks, please wear proper insulation gear while installing this device.
- Be certain to use the correct gauge of wire, see below for a table of recommended wire size for various current loads.

Solar Input Current	5A	10A	20A	30A	40A	60A
Wire Cross Section Area (mm ²)	1.5	2.5	5	8	10	12
Wire AWG	15	13	10	8	7	6

* We suggest no more than 5A's current for each square millimeter's wire core, e.g., for current of 10A, at least you should use 2mm²'s wire.

3. Product Features

Thank you for choosing our products. This MPPT solar charge controller is a device for solar charge regulation and direct current output load control. This device is mainly used in small and medium sized off-grid solar power systems.

These MPPT charge controllers have features as follows:

- By continuously checking solar panel power output changes, the controllers employ multiple MPPT charge algorithms in combination to boost charging efficiency in different weather and temperature conditions.
- Built-in buffer, allows max 25% exceeding rated power input.
- Charging modes available for most common deep-cycle battery types in the market, including AGM (sealed lead acid batteries), GEL, Flooded, and Lithium. USER mode also available for customized parameters setting.
- Allows mobile phone APP operation for monitoring and parameters settings, with connection of external blue tooth communication module (optional accessory, not in the standard package list).
- Auto recognition of 12V/24V battery system voltage by M2420N/M2430N/M2440N model; auto recognition of 12V/24V/36V/48V battery system voltage by M4860 model. Lithium battery excluded from this feature.
- Supports recording of system running data including power generated and power utilized for up to 300 days, compatible with monitoring App through IOS and Android. You can search "ChargePro" and download the APP at IOS APP Store and Google Play Store.
- Provides multiple load control mode options for light based, time based and manually adjusted scenarios. Low no-load loss.
- Industrial grade design with full range of electronic protections, such as battery over-charge, battery over-discharge, PV over-voltage, controller over-heating, DC load short-circuit, DC load over-load, as well as reverse polarity protection for PV and battery sides, and etc.
- Supports RS485 communication with Modbus protocol (RJ12).
- Supports parallel charge function of dual units by linking each other with the parallel charge cable (optional accessory, not in the standard package list).
- Supports remote display screen for monitoring and operation, linking through RJ12 port in the controller. (optional accessory, not in the standard package list).

4. Device Diagram

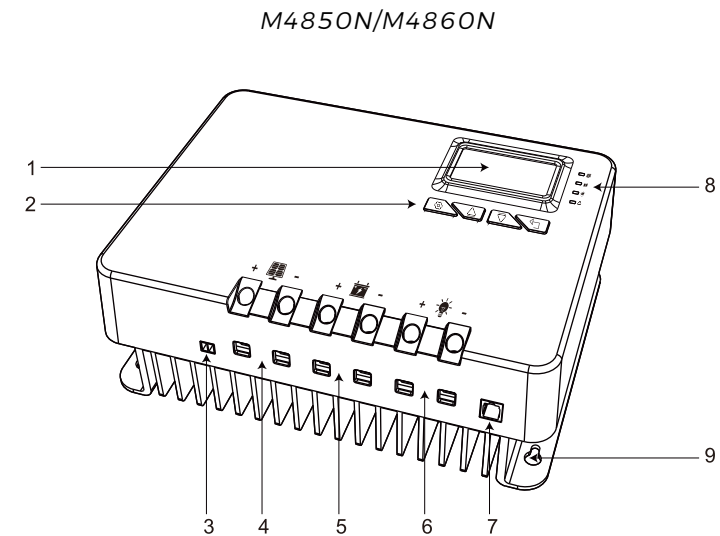

#	Description	#	Description
1	LCD Display Screen	6	DC Load Terminals
2	Function Key ([SET], [UP], [DOWN], [ESC])	7	RS485 Communication Port (RJ12)
3	External Temperature Sensor Terminal	8	LED Indicator (PV, BAT, LOAD, FAULT)
4	Solar Terminals	9	Installation Mounting Holes
5	Battery Terminals		

5. Mounting Instruction

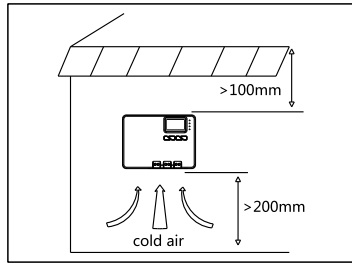

Step 1

Find a cool, dry and weather safe location for installation.

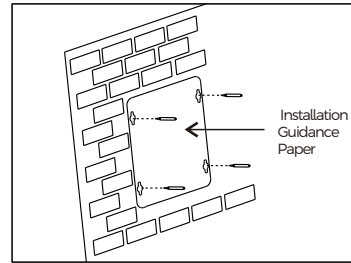

Step 2

Mark 4 positions in the mounting surface through the 4 pilot holes in the pilot paper, as the installation holes.

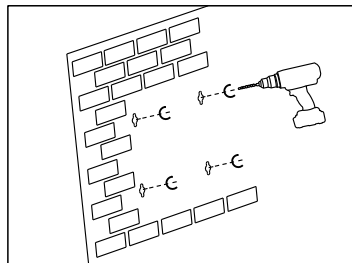

Step 3

Drill holes in the marked mounting hole location.

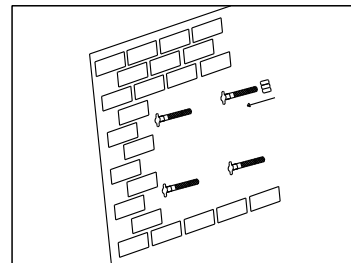

Step 4

Insert pilot screws in the mounting hole.

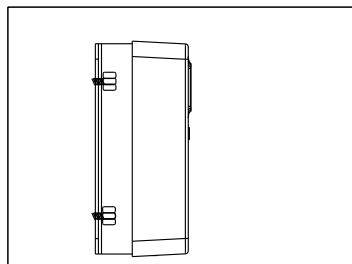

Step 5

Fasten the controller into the pilot screws.

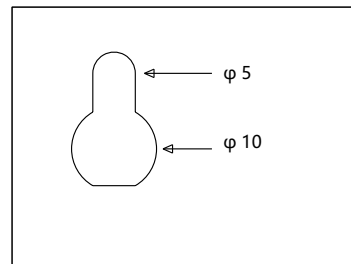

Step 6

Continue to wire battery, solar, DC load and other accessories to the controller.

6. Wire Connection Sequences

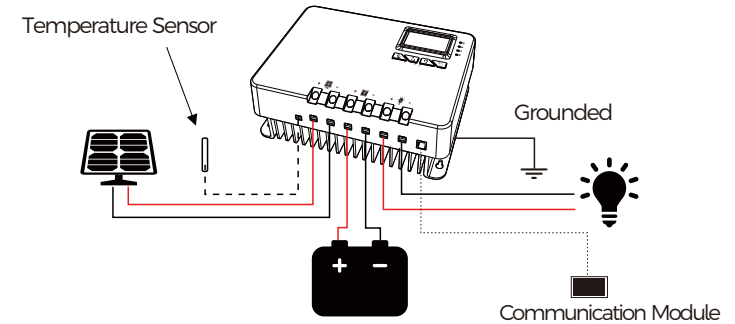

During installation of your MPPT controller, please follow the order of connection below:

- Connect the positive battery wire followed by the negative battery wire.
- Make sure your solar panels are fully covered to prevent electrical shock.
- Connect the positive solar array output wire followed by the negative solar array output wire.
- Connect DC load wires to the DC load output (if applicable).
- Connect the external temperature sensor to its terminal shown above, and attach or stick the temperature sensor to the battery side.
- Download APP "ChargePro" and turn on the BT function in the mobile phone. Testing the APP function with the controller.

7. Connecting to the ChargePro app (iOS/iPadOS)

(iOS/iPadOS)



Apple and the Apple logo are registered trademarks of Apple Inc.

Download the "ChargePro" app (iOS/iPadOS) to set up your charge controller and monitor real-time data for enhanced charging experience.

8. Connecting to the ChargePro app (Android)

(Android)



Google Play and the Google Play logo are trademarks of Google LLC.









Download the "ChargePro" app (Android) to set up your charge controller and monitor real-time data for enhanced charging experience.

9. LED Light Signal Interpretation Chart

LED Name	LED Display	Signal Indication
PV	Off	Solar Input Not Charging *PV LED is generally off during nighttime.
	Double Flash	Solar Input Detected / Solar Over Voltage
	Steady On	MPPT Charge Mode
	Slow Flash	In Equalize/Boost/Float Charge
BATTERY	Single Flash	Battery Input Reverse Polarity
	Fast Flash	Battery Over Voltage
	Slow Flash	Battery Over Discharged
	Steady On	Battery On
LOAD	Off	Load Off
	Fast Flash	DC Load Short Circuit / Overload
	Steady On	DC Load On
FAULT	Off	No Errors
	Steady On	System Error – Check Error Code

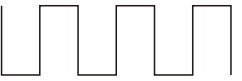
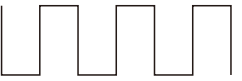
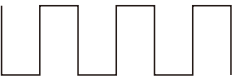
*Check the Fault light to spot if a system error may be present.

10. LED Flash Rhythm Chart

Flash Status	Indication	Description
Steady On	on  off 	LED light on.
Off	on  off 	LED light off.
Fast Flash	on  off 	LED light blinks at frequency of 2Hz (twice every second).
Slow Flash	on  off 	LED light blinks at frequency of 0.5Hz (once every two seconds).
Single Flash	on  off 	LED light blinks for 0.1 second after every 2 seconds.
Double Flash	on  off 	LED light blinks for 0.1 second twice after every 4 seconds.

11. RS485 Connection Diagram (RJ12)

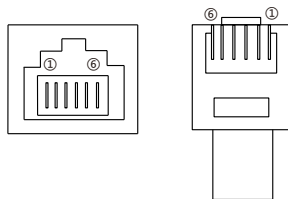



RS485 PIN (RJ12)					
PIN-1	PIN-2	PIN-3	PIN-4	PIN-5	PIN-6
VDD	VDD	GND	GND	D-	D+

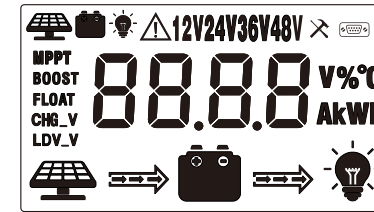

*Support 3.3V, 20mA

12. LCD Display Interface Overview



Display Section	Display Layout
Charge and Load Status	
Charge Mode & Parameter	
Active Functions	

13. LCD Status Information

Status Icon	Indication	Status	Description
	Solar Charge Indication	Flowing	Solar Power Charging Battery
		Off	Solar Power Not Charging Battery
	DC Load Indication	Flowing	DC Load Drawing Power
		Off	DC Load Off
MPPT	Charge Mode	Steady On	MPPT Charge Mode
BOOST			Boost Charge Mode
FLOAT			Float Charge Mode

Status Icon	Indication	Status	Description
CHG_V	Voltage Setting (Only for Li and User)	On	Setting Charge Voltage
		Off	Charge Voltage Has Been Set
LDV_V	Over Discharge Volt Settings (Only for Li and User)	On	Setting Discharge Voltage
		Off	Discharge Voltage Has Been Set
12V24V36V48V	System Volt	One of 12V/ 24V/36V/48V ON	Current System Voltage
	Warning	On	System failure occur
		Off	No System failure
	Setting	On	Setting Mode
		Off	View Mode
	communication	On	In the Modbus communication
		Off	No communication
	Solar Icon	Steady On	Daylight Detected
		Off	No Daylight Detected
		Fast Flash	Solar System Over Voltage
	Battery Icon	Steady On	Battery Connected and Functional
		Off	No Battery Connection
		Fast Flash	Over Voltage
		Slow Flash	Battery Over-Discharged or Reverse Connection
	Load Status	ON	Load On
		OFF	Load Off
		Fast Flash	DC Load Short Circuit
		Slow Flash	Over Load

* There is no charge mode displayed in the controller screen when it's in equalize charge mode.

14. Key Functionality Chart

Function Key	System Mode	Input	Input Function
	View Mode	Long Press	Enter SET mode
	View Mode	Short Press	View Previous Page
	View Mode	Short Press	View Next Page
	View Mode	Short Press	DC Load On/Off (Manual Control Program Only)

Function Key	System Mode	Input	Input Function
	Set Mode	Long Press	Save Data & Exit SET Mode
		Short Press	Next Setting Item
	Set Mode	Short Press	Increase Parameter Value
	Set Mode	Short Press	Decrease Parameter Value
	Set Mode	Short Press	Exit SET Mode Without Saving

15. LCD Display Rules & Cycles

LCD Screen Display Cycle

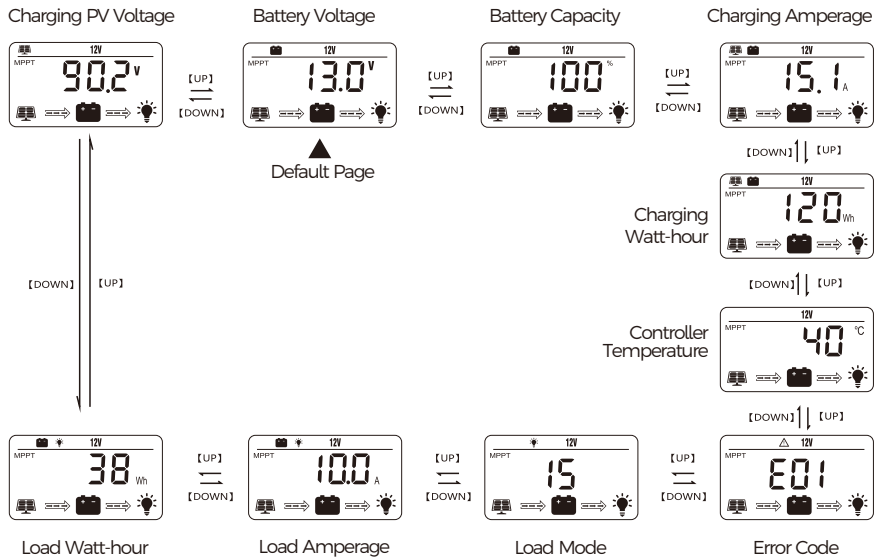

The battery voltage view will be displayed by default. Use the up and down arrow keys to cycle through different views. The battery voltage view will resume upon 30 seconds of inactivity. The error code view will be displayed when an error is detected. The backlight in the screen will be on for 20 seconds with any button operation.

Setting Battery Mode

Enter SET mode by long pressing the SET key in any view page other than Load Mode. Use the up and down arrow keys to select battery mode, then long press SET key to save.

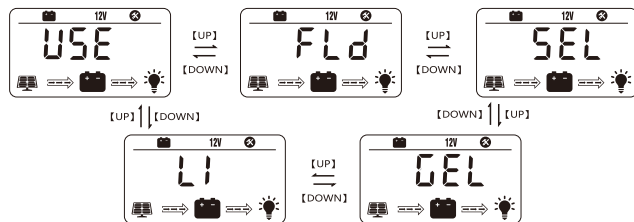

Abbreviations	Battery Types	Description
FLD	Flooded Battery	Auto-recognition with default parameters set for each type of batteries.
SEL	Sealed/AGM Battery	
GEL	Gel Battery	
LI	Lithium Battery	Some parameters can be customized.
USE	Advanced User Mode	Most parameters can be customized.

Advanced Battery Settings

In Lithium or User mode, short press the SET key again to cycle through each parameter view. Use the up and down arrow key to adjust parameter value, then long press SET key to save.

For Battery Type: Li

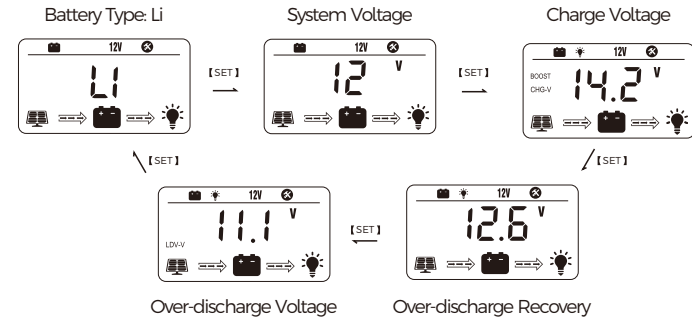

For Battery Type: USER

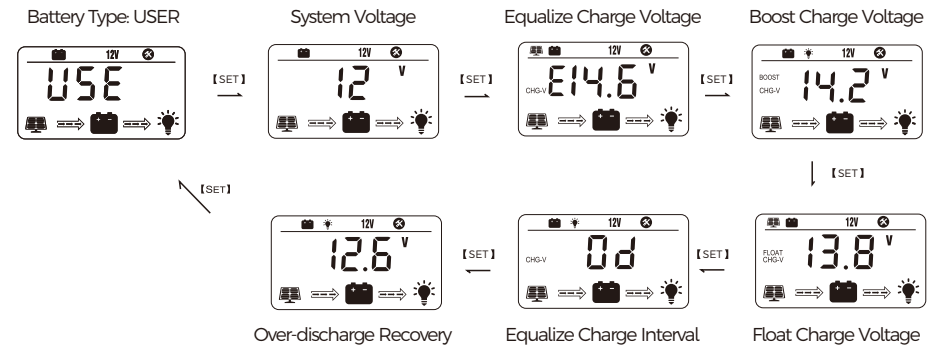

Load Mode Settings

Enter Load SET Mode by long pressing the SET key in Load Mode view only.

Use the arrow key to cycle through load modes before long pressing SET to save and exit.

Short pressing ESC will exit without saving.

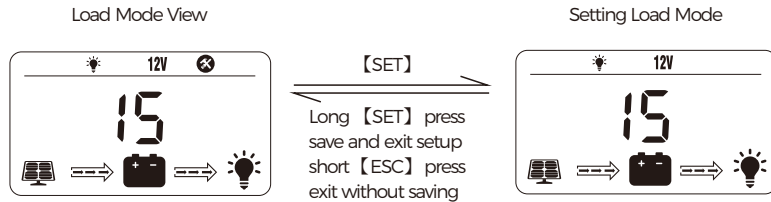

Mode	Definition	Description
0	Daylight Auto-Control	DC load turns on when no daylight is detected.
1-14	Daylight On/Timer Off	DC load turns on when no daylight is detected. DC load turns off according to timer.
15	Manual Mode	DC load turns on/off by pressing the Return key.
16	Testing Mode	DC load turns on and off in a quick succession.
17	Always On	DC load stays on.

*For load mode 1-14, the number means the load lasting time, e.g., "1" means the load would turn off in 1 hour after turning on, "8" means off in 8 hours. Please notice that the sunlight would turn off the load for all load modes 1-14, even the timer hasn't run out yet.

16. Error Code Chart

Code	Error	Description & Quick Troubleshoot
E00	No Error	No action needed.
E01	Battery Over-discharged	Battery voltage is too low. DC load will be turned off until battery re-charges to recovery voltage.
E02	Battery Over-voltage	Battery voltage has exceeded controller limit. Check battery bank voltage for compatibility with controller.
E04	Load Short Circuit	DC load short circuit.
E05	Load Overload	DC load power draw exceeds controller capability. Reduce load size or upgrade to a higher load capacity controller.
E06	Overheating	Controller exceeds ambient temperature limit. Ensure the controller is placed in a well-ventilated cool, dry place.
E07	Environmental Overtemperature	The environment temperature sampled by external temperature probe is too high.
E10	Solar Over-voltage	Solar array voltage exceeds controller rated input voltage. Decrease the voltage of solar panels connected to the controller.
E14	Battery Reverse Polarity	Battery connection wires connected with reverse polarity. Disconnect and re-connect with correct wire polarity.

*Please contact professions for technical support on additional troubleshooting.

17. Controller Specification

The variable "n" is adopted as a multiplying factor when calculating parameter voltages, the rule for "n" is listed as: if battery system voltage is 12V, n=1; 24V, n=2; 36V, n=3; 48V, n=4.

For example, the equalize charge voltage for a 12V FLD (Flooded) battery bank is $14.8V \times 1 = 14.8V$. The equalizing charge voltage for a 24V FLD (Flooded) battery bank is $14.8V \times 2 = 29.6V$.

Parameter	Value				
Model No.	M4850N		M4860N		
System WModel No.	Negative Grounded				
Battery System Voltage	12V/24V/36V/48V Auto (FLD/GEL/SLD/USE) Manual (Li/USE)				
No-load Loss	12ma(12V), 10ma(24V) 5ma(36V), 5ma(48V)				
Max Solar Input Voltage	<150Voc				
Rated Solar Charge Current	50A		60A		
Max Solar Input Power	750W/12V; 1500W/24V 2200W/36V; 2700W/48V		900W/12V; 1800W/24V 2600W/36V; 3200W/48V		
Light Control Voltage	5V*n				
Light Control Delay Time	10s				
Max Load Output Current	20A				
Operating Temperature	-35°C ~ +45°C				
IP Protection	IP32				
Net Weight	3.0 kg		4.55 kg		
Communication Port	RS485 (RJ12)				
Operating Altitude	≤ 3000 meters				
Controller Dimension(mm)	280*210*90		280*210*102.7		
Parameter	Battery Parameters				
Battery Types	FLD	SEL	GEL(default)	USER(adjustable)	LI (adjustable)
Equalize Charge Voltage	14.8V*n	14.6V*n	--	Default	--
Boost Charge Voltage	14.6V*n	14.4V*n	14.2V*n	Default: GEL	Default: 14.2V*n
Float Charge Voltage	13.8V*n			Default: GEL	--
Boost Charge Recovery Voltage	13.2V*n			Default: GEL	--
Over-discharge Recovery Voltage	12.6V*n			Default: GEL	--
Over-discharge Voltage	11.1V*n			Default: GEL	Default: 11.1V*n
AutoTemperature Compensation	-3mV/2V/°C			Default: GEL	--

18. Product Dimension

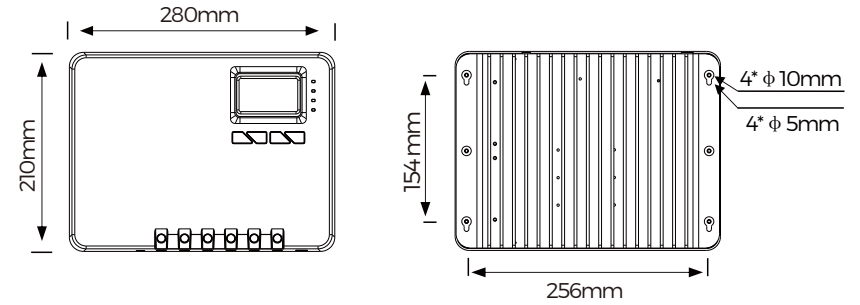

M4850N Model

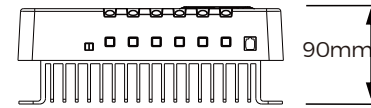

M4860N Model

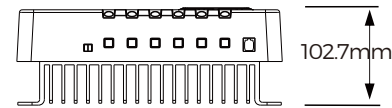

Model	M4850N	M4860N
Product Dimension	280*210*90mm	280*210*102.7mm
Installation Area Dimension	256*154.5mm	256*154.5mm
Installation Hole Size	φ5mm&φ10mm	φ5mm&φ10mm
Connection Socket Size	10*10mm	10*10mm