

# SI-10/12/15/18 Infrared Touchless Sensor Operation & Installation Manual

Suitable for access control system, push button and auto-control detection.

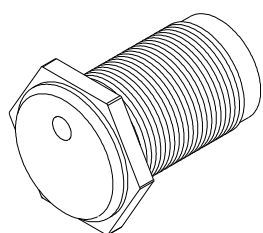

**SI-10**

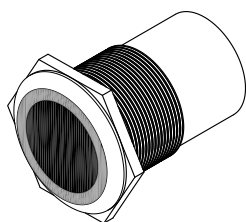

**SI-12**

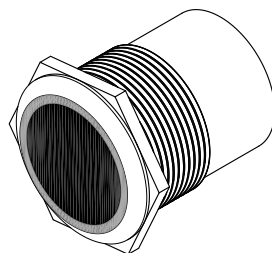

**SI-15**

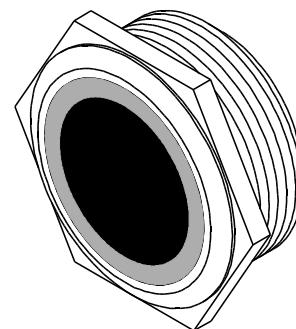

**SI-18**

※ Please make sure no object(Include protection stickers) is blocking the infrared sensing panel before use.

## I. Features







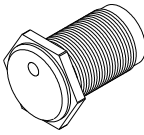
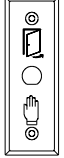
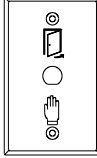
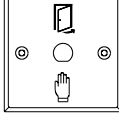

- Diameter of 19mm ,22 mm or 38mm to accommodate and mount in different panels.
- Activate without pressing to prevent any disease contagion. It is suitable for access control system that widely used in public areas such as hospitals or restaurants. It is also can be used as auto-control detection.
- Built-in microcontroller with power on self testing function.
- Specially designed to prevent any interference from other infra-red.
- Double color status light, adjustable proximity range.
- Door opening time is able to set trigger state (0.5~30sec) or toggle mode output
- Operating temperature : -10°C ~ +70°C.
- Sealing protection Ip65.
- Infrared proximity has a total lifespan of 100,000 hours. Relay has a total lifespan of 1,000,000 times.

## II. Specification

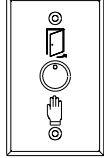
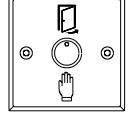
	SI-10	SI-12	SI-15	SI-18	Note
Power input	DC12V~DC24V				±10%
Range	4~15CM(±25%)				Note1
Output Loading	1A@DC30V(Max.)				
Output State	Trigger state (0.5~30sec) or toggle mode output				
Life Time	Infrared sensor:100,000 hours / Relay mechanical lifespan:1000,000				
Indicator	Standby : RED Proximity : GREEN	Standby : RED Proximity : GREEN	Standby : RED ; Proximity : GREEN Color of indicator light is adjustable		
Case	Polycarbonate fireproof	Stainless Steel	Stainless Steel		
Current Consumption	Maximum current 30mA	Maximum current 30mA	Maximum current 35mA	Maximum current 45mA	DC 24V
Dimensions	Ø19mm	Ø 19mm	Ø 22mm	Ø 38mm	
Weight	10g	21g	24.5g	50g	

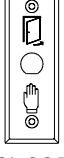
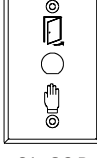
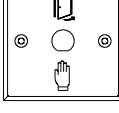
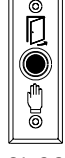
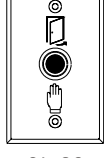
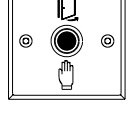
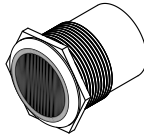
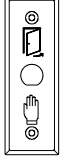
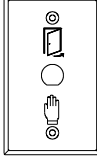
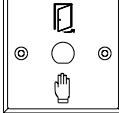
※ Note1 : Different materials have different reflective rate. The value of the chart is based on the test of 18% neutral gray card.

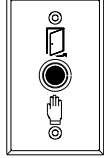
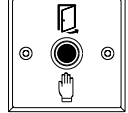
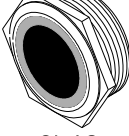
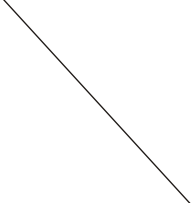
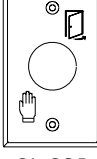
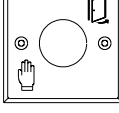
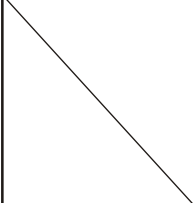
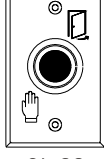
### III. Model numbers

Single switch	Template			Package		
 SI-10	 SI-20P	 SI-60P	 SI-80P	 SI-20	 SI-60	 SI-80
 SI-12	 SI-22P	 SI-62P	 SI-82P	 SI-22	 SI-62	 SI-82
 SI-15	 SI-25P	 SI-65P	 SI-85P	 SI-25	 SI-65	 SI-85
 SI-18		 SI-68P	 SI-88P		 SI-68	 SI-88

### IV. Installation

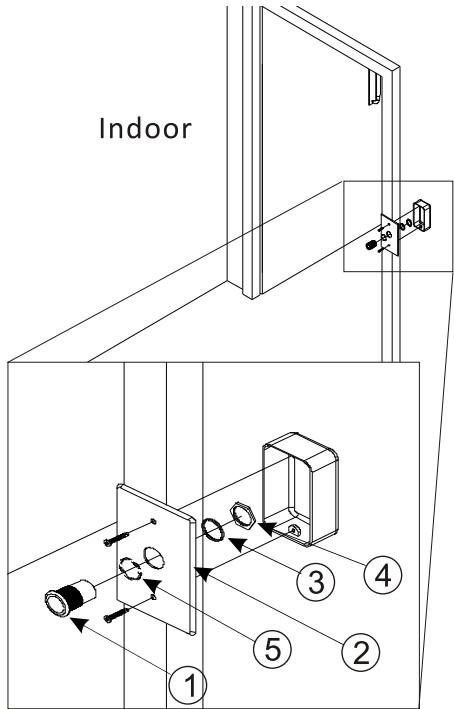

Indoor

① Sensor ② Panel ③ O-ring ④ Nut

NOTE : Please insert the waterproof washer in the infrared receiver and then place it into the lock template to enhance its waterproof effect. For example ⑤.

**SI-10**

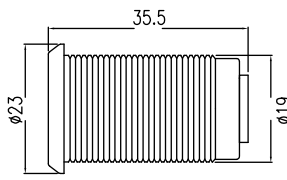

**SI-12**

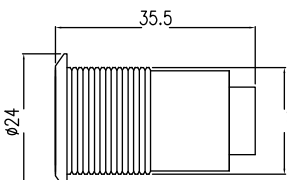

**SI-15**

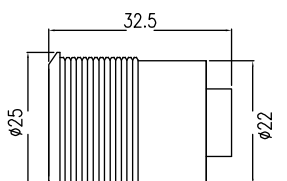

**SI-18**

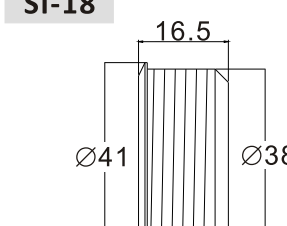

**PLEASE NOTE !!**

In order to ensure the operation of the infrared switch, please make sure no objects or any obstacles within 30cm(60° on the left and right) of the front panel of the switch to avoid any interference.

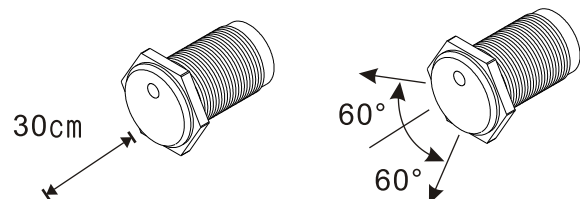

# V. Panel & Wirings

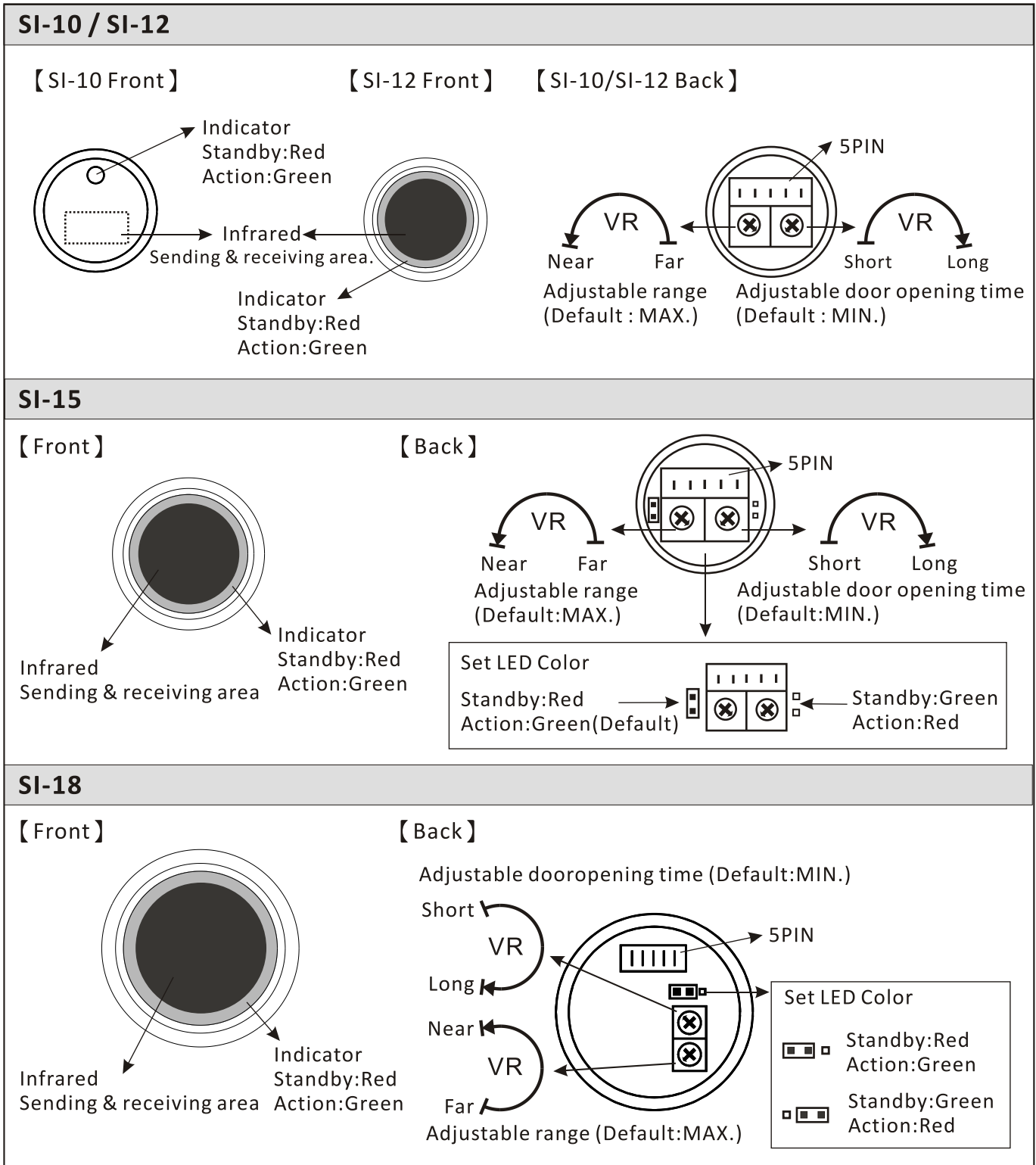

※ Example of SI-10 ; adjust door opening time to the maximum (turn VR to the right end) to change door opening Relay as Toggle mode output (such as the switch function).

5-PIN :

PL	Door control relay. (N.O.)
BU	Door control relay. (COM)
GN	Door control relay. (N.C.)
BN	GND
RD	DC+12V~24V

Panel Size :

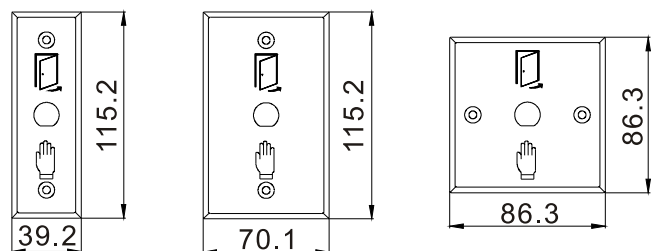

Unit:mm

## VI. Example of wirings :

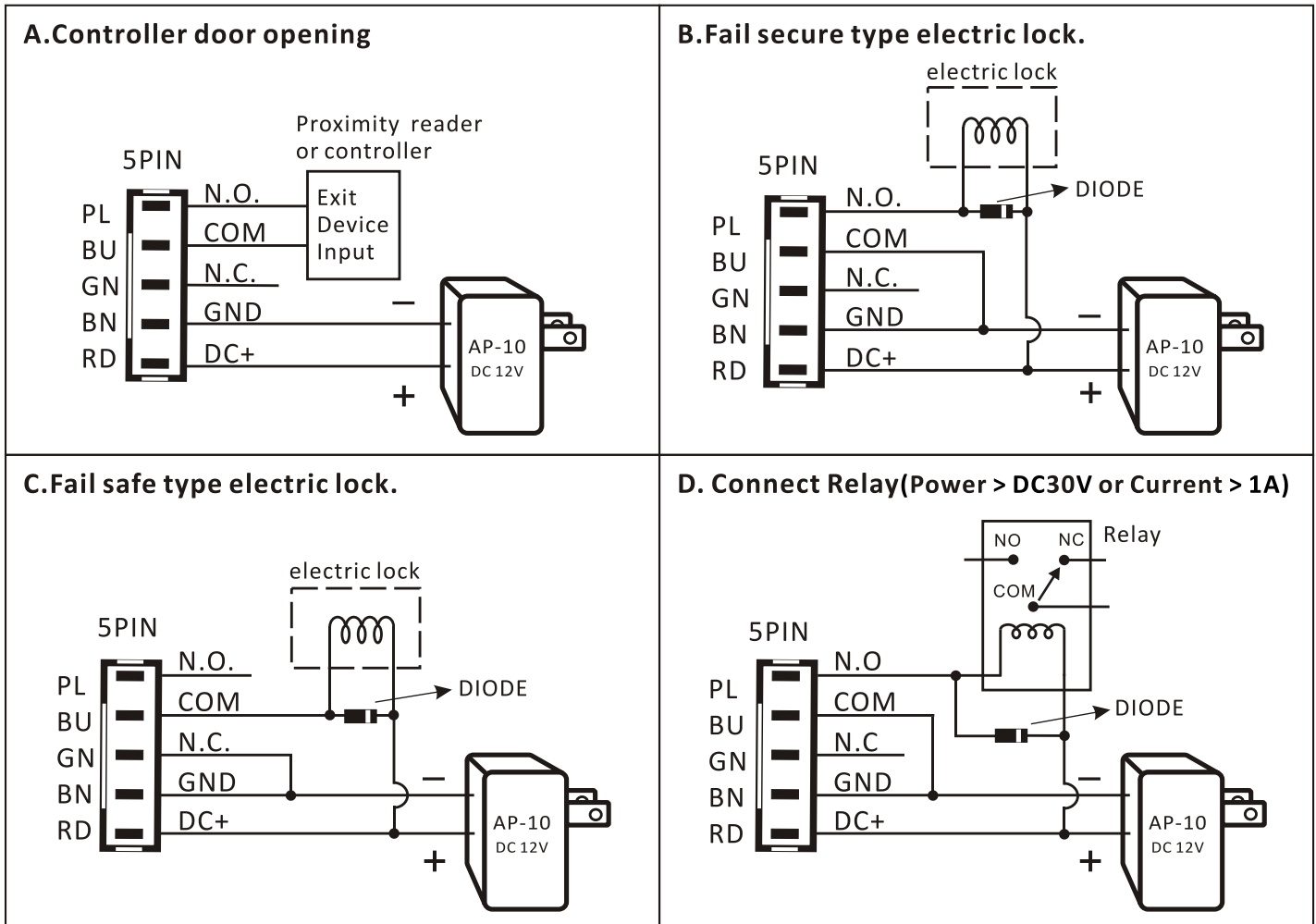

※ Please connect to diode when the control terminal is loading in order to absorb surge to prevent damage to the sensor.

### Troubleshooting

Q : Always on action mode (indicator light does not change).

- A :
1. Please wipe the surface clean such as oil stain, liquid drops or marks and remove any objects in front of the proximity that may interfere its proximity range.
  2. Please adjust the proximity distance. Shorter the distance may avoid interference.
  3. Please check the voltage. Lower voltage may shorten the proximity distance or cause the switch unable to function.
  4. Please check the delay setting time. If it is being set as too long or Toggle mode, it might affect its operation.

Q : Proximity failed even the infrared switch's power light is on.

- A :
1. Please adjust the proximity distance to check if it is too short.
  2. Please check the current (12V~24V).The switch is unable to function if the voltage is incorrect.

## VII. Precautions

1. Before input power, please check the voltage and polarity of the power supply in order to avoid wrong connection causing damage to the reader.
2. Please make sure no object(Include protection stickers) is blocking the infrared sensing panel before use.
3. Please do not conduct any fixing or modification to the system, unless by qualified personnel.
4. Self testing function : Green light on for one second and no action from Relay → red light on to complete power on self testing.
5. Warranty of the unit is one year under normal circumstances.